

A10004 Unmonitored









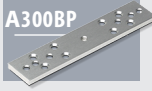

A10004DS Unmonitored with Door Status

Unmonitored Double Mini Magnet

- Operating voltage 12~24Vdc (*Selectable*)
- Aluminium housing
- Holding force up to 2 x 600lbs (*272Kg*)
- Electro-less Nickel Plated Armature
- Fail-Safe



OPTIONS

 A300BP	 A320M	 A300ZL	 A300ZLDC	 A300AL	 U300CL	 GDB14
 A01EXTP	 300ZLG	 LD-MM-SC				

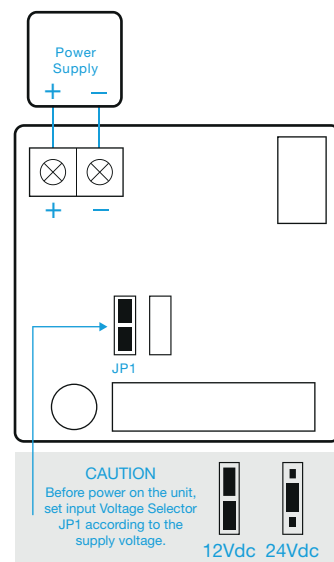
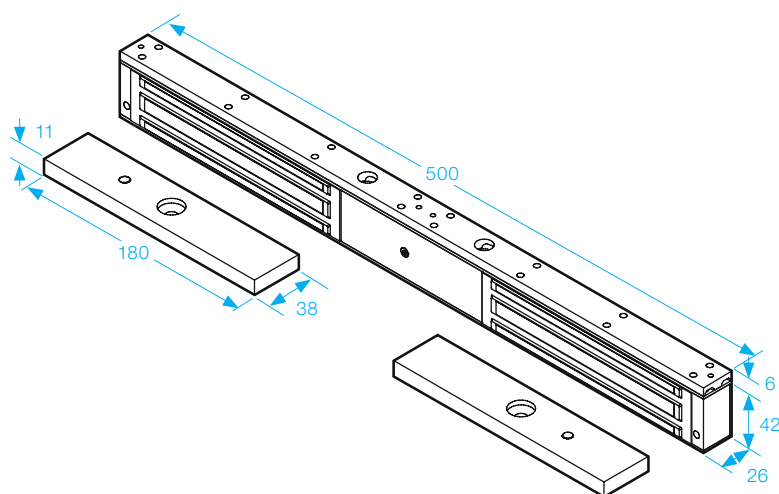

SPECIFICATION

- Voltage tolerance: $\pm 10\%$.
- Current draw: 480mA at 12Vdc, 240mA at 24Vdc (at temperature 20°C).
- Operating temperature: -10~55°C (14 to 131°F).
- Lock's surface temperature: Current temperature $\pm 20\%$ (when power is on).

- Humidity: 0~95% non-condensing.
- Aluminium housing, nickel plated armature.
- Weight: 3.7kg (approx).