

DRB054S-ITW-PTE

Exit Button

- Brushed Stainless Steel Plate
- **ITW** Green dome button
- Surface mount
- ABS Plastic Housing
- COM-N/O - N/C
- Supplied with security screws

SPECIFICATION

- Max. Rating: 5A/125/250 Vac.
- Contact resistance: 50mΩ Max. (*Initial*).
- Operating travel: 2.7mm.
- Operating life (*Mechanical*):
Over 100,000 times.
- Cables included.

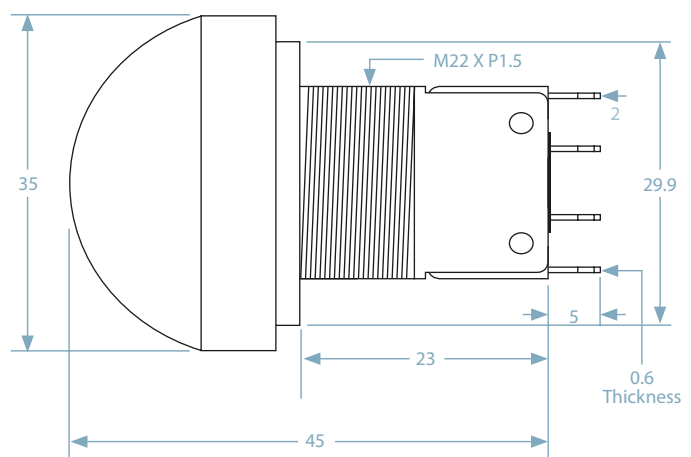
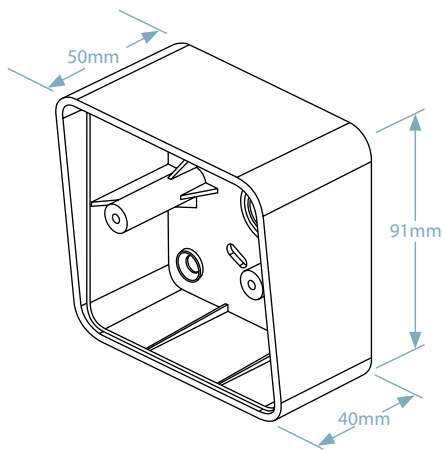

Operating Travel 2.7

