

DG-180

Digital Keypad Operation Manual

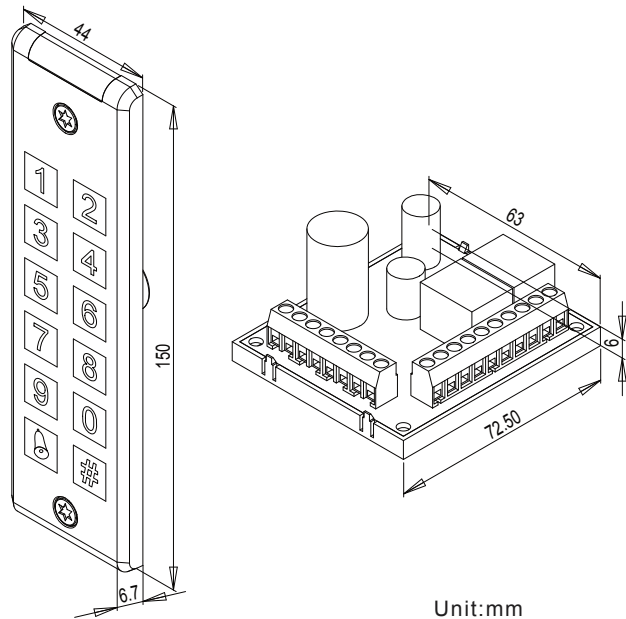

Unit:mm

Features:

- Adjustable length of Master Code from 4 to 6 digits.
- Allow up to 1000+10 PINs
- Split-off controller and keypad for high security.
- Lockout function enables the controller to lockout for 60 seconds upon entering invalid PINs for 5 times. (The keypad without beep sound during the period).
- Controller with keypad sound to avoid incorrect key-in.
- Additional input for anti-tailgating function to ensure high security access control.
- Built-in tamper switch.
- Non-volatile memory allows to retain all setting codes in the event of total power failure.
- Dual relays to control door lock and other security devices.
- Aluminum alloy casing with vandal resistant screws for enhanced safety and durability.
- Epoxy sealed for waterproof
- Extremely slim body and narrow faceplate suitable for all types of door frames

Specification

Operating Voltage	12~24 VAC/VDC
Current Draw	Pull in: 50mA/12VDC ; Holding: 20mA/12VDC Pull in: 80mA/24VDC ; Holding: 20mA/24VDC
Keypad	6X2 matrix keypad (0~9, *, #)
Input	2 contacts for Request-To-Exit 1 contact for Door Reed Switch
Output	2 relays (N.O. / N.C. / Com.)
LED status Indication	2 LED indicators display (Blue/Green/Yellow/Red)
Memory Volume	1000+10 PINs
Relay Rating	N.O 10A/120V~10A/120VAC, N.C 7A/250V~10A/28VDC
Relay Strike Time	01~99 seconds
Ambient Humidity	5%~95% (Non-condensing)
Operating Temperature	-20°C~70°C

Status Indication & Default Setting Parameters

Beep & LED Indication:

	Mode	Signal	Status
LED	Standby	Blue Stay On	Power on, Standby
		Green Stay On	First relay active
		Red Stay On	Second relay active
	Programming	Yellow Stay On	Enter programming mode
		Green Stay On	The slot position of first relay is available.
		Red Stay On	The slot position of first relay is unavailable.
Green Stay On Red Stay On		The slot position of second relay is available. The slot position of second relay is unavailable.	
Beep	Standby	1 Beep	Press any key , enter programming mode
		2 Beeps	Incorrect PIN
	Programming	1 Beep	Correct Input data, Exit programming mode
		3 Beeps	Incorrect Input data, other incorrect operation, duplicated PIN

Factory Default Setting:

Master Code	1234 (4-digit)
Relay Strike Time	1 second
Pressed Key Time Delay	5 seconds (Fixed)
Programming Mode Time Delay	30 seconds (Fixed)

Wiring Diagram

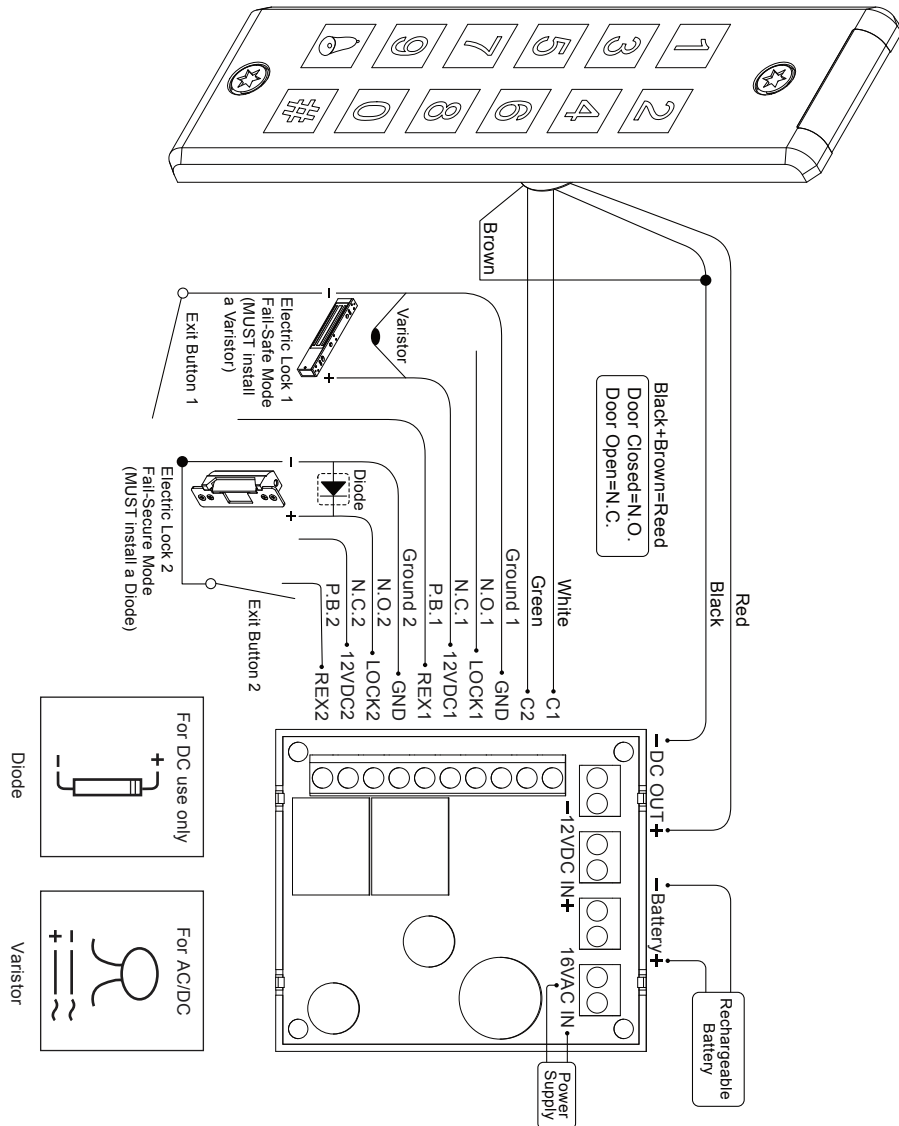

Note:

1. It is suggested to use a linear power supply unit to prevent power rating reduction from the keypad.
2. It is suggested to use #22~26 AWG insulation wire.
3. Exit button is at N.O. contact.
4. With CE qualification EMC specification.
5. The door strike or relay must have a varistor or a diode across the door strike terminals to suppress the back EMF of the strike – failure to do so will damage the relay contacts and electronic components, or even burn the controller.

Operation Instruction

1. Master Code

The master code comprises a four-digit number and is used to access programming functions of the digital keypad and cannot be used for access request i.e. it cannot be the same as other PINs. The default master code is 1234. Under normal operation entering PIN will gain access. In the programming mode the keypad can be used to add/delete PINs, set relay strike time and other operation functions.

2. Entering programming mode

Enter the master code twice 1234 1234 to enter programming mode (1 beep Yellow LED stay on).

3. Setting the Relay Strike Time

The relay strike time determines the amount of time that the door remains unlocked after a valid PIN is entered.

(Enter 05=5 seconds)

1. Enter programming mode
2. Press \odot 1 for Relay 1 (Yellow LED flash)
Press \odot 5 for Relay 2 (Yellow LED flash)
3. Press 00~99 (1 beep, Yellow LED stay on)
4. Press # (1 beep) back to standby mode (Blue LED stay on)

4. Clearing Memory of All PINs

1. Enter programming mode
2. Press \odot 8 (Yellow LED flash)
3. Press 88 (Yellow LED stay on, 7 beeps)
4. Press # (1 beep) back to standby mode (Blue LED stay on)

5. Resetting Controller Parameter to Factory Default Value



1. Enter programming mode
2. Enter \odot 8 (Yellow LED flash)

3. Enter 99 (Yellow LED stay on, 1 beep, Green LED flash) back to standby mode (Blue LED stay on)

6. Adding PIN to Relay 1



- a. 1. Enter programming mode to select slot position 000~999 (Green LED stay on indicate the slot position is available)
2. Press 4-digit PIN (1 beep, Yellow LED stay on).
3. Press # (1 beep) back to standby mode (Blue LED stay on)

NOTE: Master code must NOT be the same as PINs.

- b. 1. Enter programming mode to select slot position 000~999 (Red LED stay on indicate the slot position is unavailable)
2. Press   (1 beep) to delete the data from the slot position (Green LED stay on)
3. Press # (Yellow LED stay on) back to programming mode. Repeat the steps of 6-a to add PIN.

7. Adding PIN to Relay 2

- a. 1. Enter programming mode
2. Press  4 (Yellow LED flash) to select slot position 00~09 (Green LED stay on indicate the slot position is available)
3. Press 4-digit PIN (1 beep, Right Yellow LED flash)
4. Press # (1 Beep) back to programming mode (Yellow LED stay on)
5. Press # (1 Beep) back to standby mode (Blue LED stay on)

- b. 1. Enter programming mode
2. Press  4 (Yellow LED flash) to select slot position 00~09 (Red LED stay on indicate the slot position is unavailable)
3. Press   to delete the data from the slot position (1 beep, Green LED stay on)
4. Press # back to programming mode (Yellow LED on). Repeat the steps of 7-a to add PIN.

8. Changing Master Code

1. Enter programming mode
2. Press  3 (Yellow LED flash)
3. Enter 4-digit master code twice e.g. 4567 4567 (1 beep, Yellow LED stay on)
4. Press # (1 beep) back to standby mode (Blue LED stay on)

9. Turning Anti-Tamper Alarm Function ON/OFF

1. Enter programming mode
2. Press  6 (Yellow LED flash)
3. Press 01 (1 beep, Yellow LED stay on) – function OFF
Press 02 (1 beep, Yellow LED stay on) – function ON
4. Press # (1 beep) back to standby mode (Blue LED stay on)

10. Changing the length of the master code

1. Enter programming mode
2. Press  (Yellow LED flash), press 04

3. Press 4,5 or 6, e.g. press 4 for the length of 4-digit master code; press 5 for the length of 5-digit master code; press 6 for the length of 6-digit master code. (7 beeps, Yellow LED stay on).

4 Press # (1 beep) back to standby mode (Blue LED stay on)

※ After the length is changed, all PINs are cleared as well.

11. Resetting the Master Code to Default Value

Turn off the power. Press # continuously, and energize (1 beep), the master code is reset to default value.

(If the default value is 4 digits, master code is 1234; if 5 digits, 12345; if 6 digits, 123456.)

Annex: User List

User	User Name	Slot Number	PIN#
1			
2			
3			
4			
5			
6			
7			
8			
9			
10			
11			
12			
13			
14			
15			

Warranty:

The product is warranted against defects in material and workmanship while used in normal service for a period of 1 year from the date of sale to the original customer. The GEM policy is one of continual development and improvement; therefore GEM reserves the right to change specifications without notice.